



***ELECTRIC
DIRT BIKE***

RFN ARES RS

UŽIVATELSKÝ MANUÁL

1. Introduction

To all RFN owners:

Thank you for your trust to the RFN brand, we will accompany you to make exploration of the life as much as possible, look for unknown answers and wonderful off-road life.

This manual explains the correct and safe use of the vehicle and a simple inspection before using. Please read the operation instructions carefully. If you have any questions about the operation or maintenance of your vehicle, please contact an authorized dealer

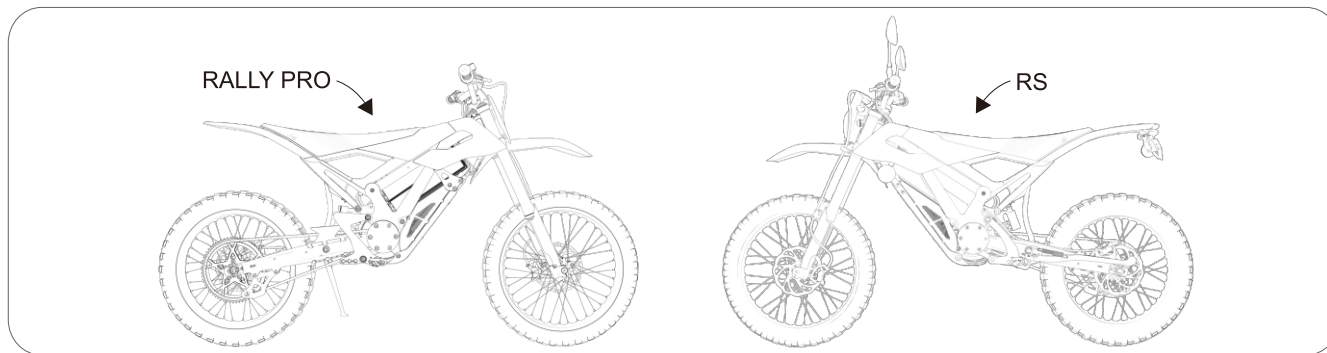

Warning

It refers to a warning instruction to be abided by and failure of abiding by the warning may result in serious injury or death of the vehicle operator.

Caution

Warning refers to a special precaution to avoid damage to the vehicle and it indicated the important information in this manual.

Caution

Please always leave this manual to the next owner for maintenance/service records, even if the vehicle is sold out. This manual contains most of the information related to the vehicle. However, the manufacturer will continue to improve its product design and quality which may result in differences between the manual and the actual vehicle. If you have any questions about this, please consult your dealer.

Warning

The instructions in this User Manual are prepared for your own safety. Please read this User Manual carefully before operating the vehicle to ensure that you have a thorough understanding of how to operate and control. Only if you have an official driver's license and good training can you have the ability to safely drive this vehicle. Otherwise, do not drive this vehicle to avoid injury.

Please maintain the vehicle in accordance with the prescribed vehicle maintenance interval so as to ensure the safety and prolong the service life of the vehicle.

*Products and specifications will be subject to change without separate notice

Safety depends, to a large extent, on riding skills.

The following requirements shall be abided by the driver:

The driver shall receive good driving training in all functions of the vehicle with the necessary technical instruction for off-road riding, as well as wear the protective gear for off-road equipment, and when driving, please do not drink alcohol.

Please read all maintenance instructions in the User Manual.

The vehicle shall only be repaired by an authorized dealer.

Table Of Contents

3. Safe Driving.....	4
4. Description of Vehicle Parts.....	6
5. Manufacturer Information.....	8
6. Display and control devices.....	9
7. Inspection before riding.....	15
8. Riding operation.....	16
8.1 Starting.....	16
8.2 Riding.....	16
8.3 Throttle.....	17
8.4 Braking.....	17
8.5 Selecting a riding mode.....	18
8.6 Parking.....	18
9. Regular maintenance and minor repairs.....	19
9.1 Tires.....	19
9.2 Braking System.....	21
9.3 Lubricating the brake levers.....	22
9.4 Side stand.....	22
9.5 Suspension components.....	22
9.6 Steering Bearing Inspection.....	23
9.7 Wheel bearings.....	23
9.8 Chain Tension.....	23
9.9 Battery.....	24
9.10 Fuses.....	24
10. Trouble shooting.....	25
11. Cleaning and storage.....	26
12. Technical Specifications.....	28
13. Guarantee and warranty.....	29
14. After-sales service and warranty coverage table.....	30
15. Maintenance guideline.....	41
16. Service Manual.....	42

Check the condition of the vehicle and its surroundings before starting so as to avoid accidents.

Do not lend the vehicle to a driver who is not fit to drive the vehicle.

Correct posture is important to maintain balance.

Grasp the handlebars with both hands, keep your upper body upright, and keep both feet on the pedals

Do not ride after drinking alcohol or taking drugs

Anti-armor

Please wear riding armor with protective features. off-road armor is required for driving this type of vehicle to prevent injury as much as possible.

Helmet

Your helmet constitutes the most important components of your protective gear. A well-tested helmet can prevent the driver from serious head injuries caused by accidents. Professional off-road helmets shall be worn properly.

Goggles

Ordinary glasses and sunglasses are not enough for providing adequate protection. Professional goggles for off-road helmets are required.

Off-road gloves

Professional off-road gloves with functions of joint protection and knuckle protection are required to reduce the degree of hand injury in the event of an accident.

Boots

Professional, sturdy, high-top off-road boots are required to improve leg and foot protection and riding safety.

Clothing

Professional long sleeves and pants shall be wore to protect your arms and legs. The off-road suits and armor could provide better protection.

Modifications

Modifying or removing original parts from a vehicle that has not been approved by the manufacturer may make it less safe and cause serious injury. You are responsible for the consequences caused by such kind of modification and removal.

Caution for Load

Adding accessories or increasing the load can lead to changes in weight distribution, affecting steering and balance which easily lead to the traffic accidents.

Standard Load

Max Load Capacity <120 kg

When loading locates within this limit, please remember the followings:

The center of gravity of work shall be kept as low as possible. Distribute the weight as evenly as possible to maintain balance.

Loads must be securely attached to the vehicle.

Do not hang the heavy or bulky objects on the handlebars or forks which may cause imbalance and slow steering response of the vehicle.

3. Safe Driving

Accessories

The manufacturer will only use the original accessories supplied by the manufacturer for your vehicle. Please contact an authorized dealer for this purpose. The manufacturer refuses to bear any and all responsibilities and duties for the accessories provided by third party and all of such responsibilities and duties shall be assumed by you.

When installing accessories, please remember the following:

Do not install any accessory or transport any load that obstructs or limits ground clearance, suspension travel, steering, lighting, indicators or reflectors.

Accessories installed on handlebars or front wheel suspension may impair the steering performance. Please keep the accessories to be installed as light as possible.

Do not install any luggage rack that may affect the stability of the vehicle when facing the wind.

Electrical accessories have been installed by an authorized dealer to match the capacity of the electrical system.

Improper installation may result in loss of lighting, low motor power reduction and vehicle damage.

Other Safety Instructions

Drive slowly and brake carefully on wet roads or slick surfaces.

Safety Stickers

- 1.Warning stickers of driving behavior
- 2.Warning stickers of major switch
- 3.Warning stickers of battery
- 4.Warning stickers of air pressure
- 5.Warning stickers of use

4. Description of Vehicle Parts

Left side view

- 1. Charging port
- 2. Battery fixing lock
- 3. Frame
- 4. Rear fender
- 5. Rear shock absorber
- 6. Front wheel
- 7. Front brake assy
- 8. Front suspension fork
- 9. Motor controller
- 10. Lithium battery pack
- 11. Side stand
- 12. Rear swing arm
- 13. Rear brake assy
- 14. Rear wheel

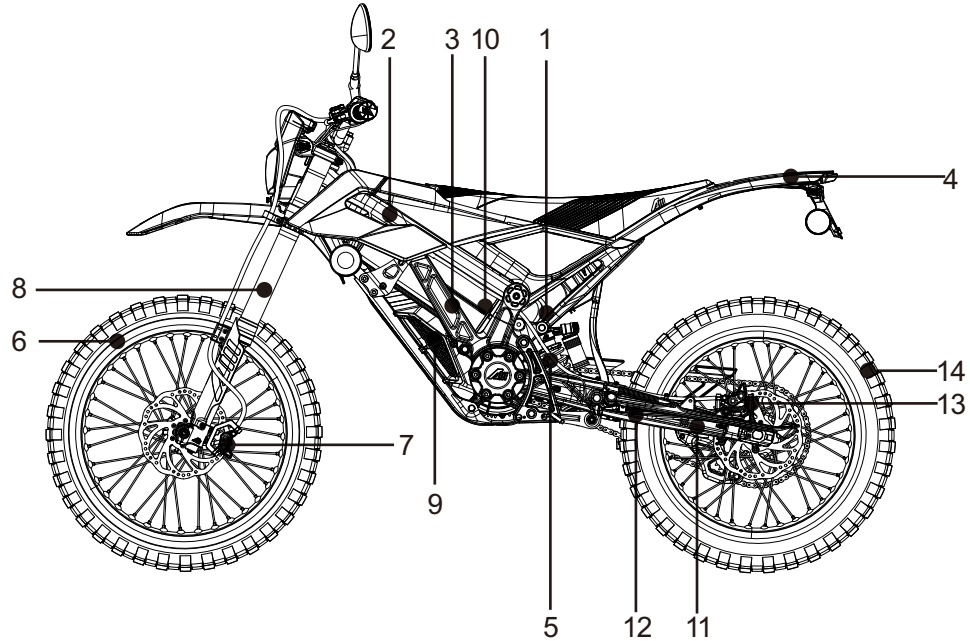

4. Description of Vehicle Parts

Top view

16. Handlebar

17. Rear brake lever

18. Instrument panel

19. Front brake lever

20. Acceleration twist throttle

21. Master key switch

22. Seat

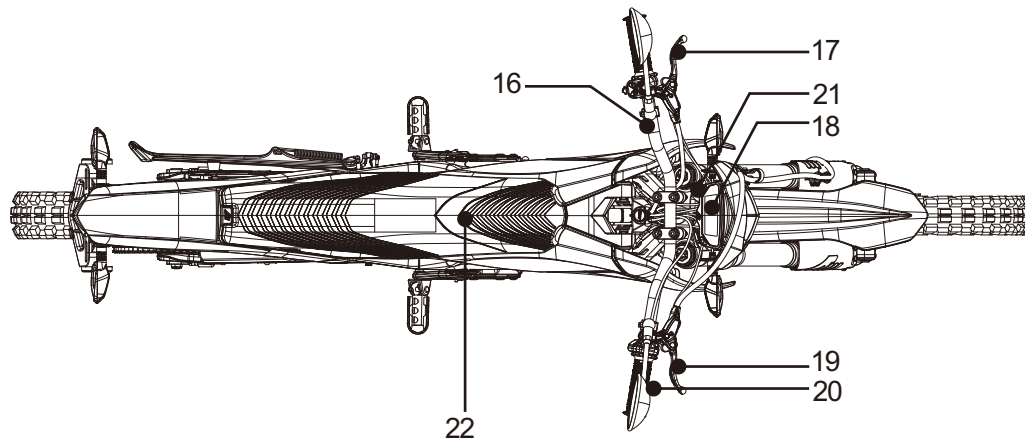

5. Manufacturer Information

Manufacturer

Name: Zhejiang Apollo Sports Technology Co., Ltd.
Add: No.12-14 of Jinheng Second Road, Jinyanshan Industrial Zone, Quanxi
Town, Wuyi County, Jinhua City, Zhejiang Province, China

Power Rating

DC brushless motor
Waterproof grade: IP67
Insulation grade: F
Rated speed: 2,200r/min
Rated power: 5KW
Rated voltage: 72V
Code: 10000-bell-111Y
Designed by AM

L08Y10T06N1000009

★ Vehicle Serial Number ★

Vehicle Serial Number

Please note that the vehicle serial number SN will be used when ordering spare parts from an authorized dealer or in the event of theft of the vehicle. It is engraved on the right side of the steering head tube of the frame.

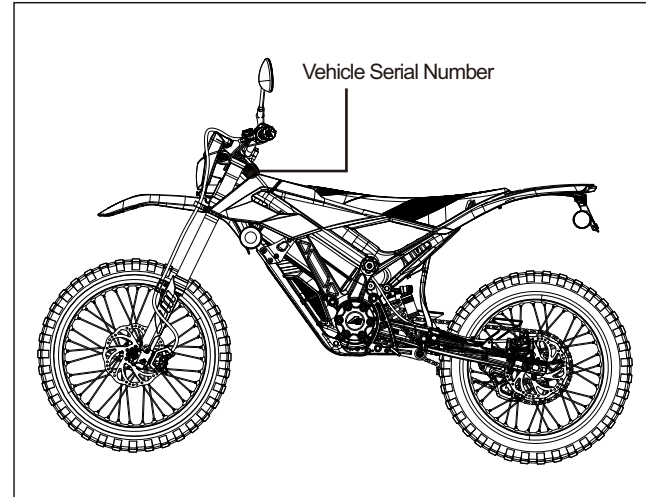

6. Display and control devices

6.1 Main Switch Controls Power:

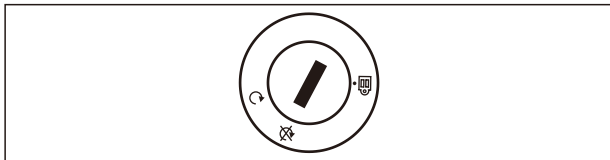

6.2 Power on Turn the key to “↻” position

The meter will light up, after retracting the side stand, “Ready” on meter lights up, it can be ridden normally.

Attention

If the side stand is put down, it will not be able to unlock P gear for riding

6.3 Turn off Turn the key to “⊗”

All electrical systems are turned off

6.4 Fault Warning

In case of a fault, the mileage value will change to a flashing fault code to indicate the specific fault; when there is a battery communication failure, the bar power display is one grid and the charging indicator flashes.

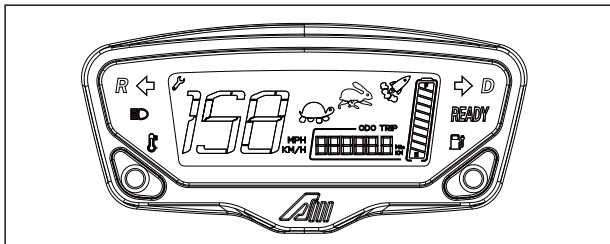

6.5 The brake lever for the front brakes is located on the right handlebar.

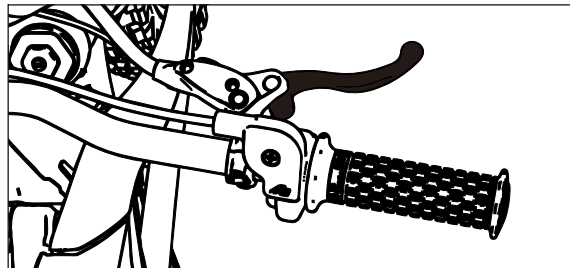

6.6 The brake lever for the rear brakes is located on the left handlebar. In case of applying the brakes, pull the lever toward the handlebars.

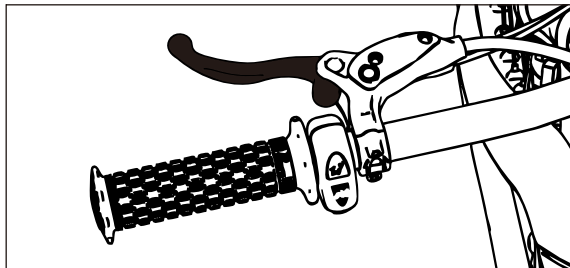

6.7 Button mechanism on the handle

- Rocket mode
- Tortoise/ rabbit mode switching
- R reverse
- Horn
- Headlight switch (long press for 2 seconds to turn on).
- Turn light

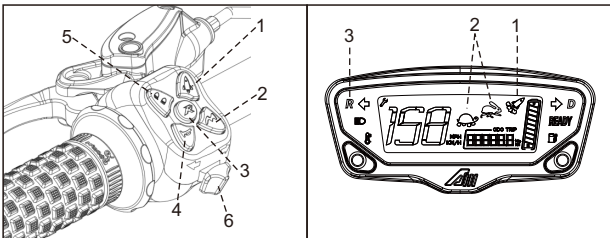

1. Rocket mode: The lower vehicle will run at peak power
2. Tortoise/ rabbit mode switching: click once to switch between tortoise and rabbit, when soc < 20 %, automatically cut into tortoise mode, rabbit and rocket are automatically disabled.
*Animated flashing indicates the current state, long light means it can enter, and light-off means it cannot enter
3. Reverse: long press for 2 seconds when the vehicle is stationary to enter the reverse mode, max speed < 9km/H

6.8 Side stand

- Side stand is located on the left side of the vehicle.
- Open the side stand to make the vehicle upright.

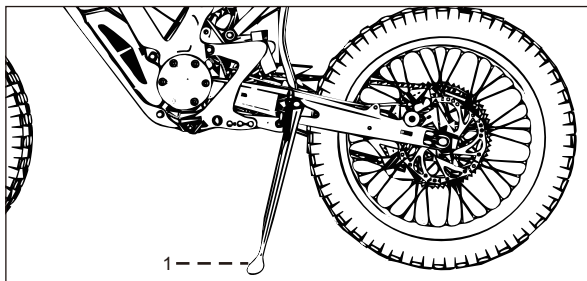

- Side stand (1) is located on the left side of the vehicle. The vehicle enters the P-gear without power output state when the side stand is open and rest for 3 mins. Hold the brake lever for 2s to unlock the vehicle into forward gear. Please noted: If the side stand is opened, the vehicle cannot output the power.

6. Display and control devices

6.9 Battery Charger

- The vehicle is equipped with the battery charger. If there is only one red indicator light left on the meter, please charge the vehicle immediately.
- Only the factory-supplied charger could be used to charge the battery.
- There are two charging modes (corresponding to the relevant indicator lights), and the charging rate can be adjusted by pressing and holding the button on the charger for 2 seconds. The charging rate can be switched between 10A or 5A.

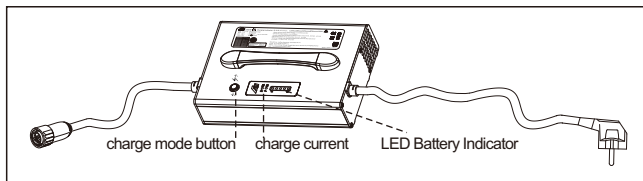

6.10 Charging Port

- The charging port (1) is located on the battery.
- The battery can be charged when it is mounted on or removed from the vehicle. It is recommended to cover the charging port dust cover when not charging to avoid foreign objects entering and damaging the charging port or corroding the charging port and other dangerous situations.

NOTE

The indicator light has the function of status indication and fault indication.

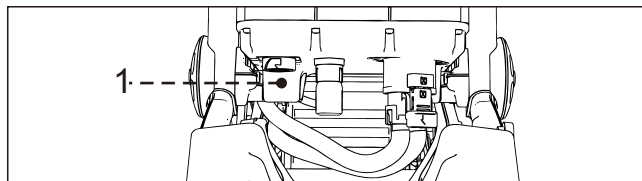

Item	Charging status	battery voltage Charging current	Indicator Status
1	Empty load	Battery Unconnected	Fast charging indicator and Slow charging indicator flash
2	Charging	Press the current switching button, the charging current can be switched between 5A and 10A (when the BMS specifies the charging current is less than 5A, press the current switching button to be invalid)	A total of 5 bar (20% -100%) capacity indicator, the corresponding indicator that are currently charging flash, the completed capacity indicator are often on; when the current switch button is changed ,the fast charging or slow charging indicator shows the corresponding 10A/5A status
3	Battery fully charger		Fast charging indicator and Slow charging indicator goes off; All capacity indicators are often on
4	error indication	Battery under voltage or short -circuit (battery voltage is lower than 44V)	The 20% and 40% battery capacity indicator flickering faster
		Battery overvoltage (battery voltage is higher than 85V)	The 20% ,40% and 60% battery capacity indicator flickering faster
		Battery anti -connection or overheating alarm	The 20% ,40% , 60% and 80% battery capacity indicator flickering faster
		Charger fault (power supply overvoltage, overcurrent, overheating)	The 20%,40% ,60% ,80% and 100% battery capacity indicator flickering faster

6.11 Battery

- The battery is located under the battery cover.

Note: Please observe the warning on the battery, including: battery charging working temperature: 0~45°C, battery discharging working temperature: -20°C~55°C

- The battery with low remaining power shall be fully charged before placing it aside for a long time, it is recommended to charge the battery every 30 days when it is not in use, and the battery may enter into the hibernation mode due to low power for more than 90 days without use.

- After entering the hibernation mode, the battery can be activated by the charger: first plug in the charger, and then connect the charger to the main supply.

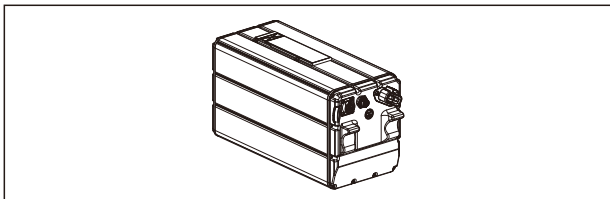

Warning!

- Do not disassemble or bump the battery.
- Do not leave the battery in an environment of which temperature fails to locate in the range of -25 ~ 70°C.
- Do not put the battery with unconnected or unsealed ports into liquids such as water, acid, alkali, salt water, etc.
- Please read the warning on the battery carefully before use.

6.12 The arc power indicator has a total of 10 grids, each corresponding to 10% power, which is reduced from top to bottom.

- Grid 1: the battery display and the outer frame flash, the remaining power is 0%-10%, please charge it immediately
- Grid 2: the battery display flashes, and remaining power is 20%
- Grid 3-10: the remaining power is 30%-100%

Caution

Please charge the battery on a regularly basis

Avoid completely using up the battery.

Do not turn on the battery while it is being charged in the vehicle.

Warning!

- If the battery drops below 20%, the power is limited, and it is forced into tortoise mode.
- If the power drops to below 10%, charge the battery immediately! Failure to do so may cause irreparable damage.

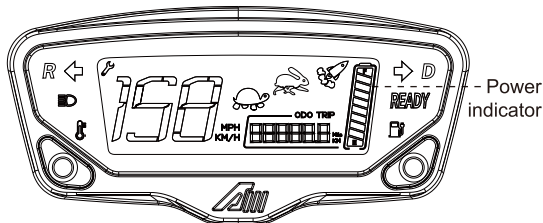

6. Display and control devices

6.13 Operation on Charging the Battery

1. Turn off the vehicle.
2. Insert the charger plug into the battery.
3. Insert the power plug into a 220 V socket.
4. The charger indicator will operate while the battery is charging.
5. When the battery is fully charged, the charger power indicator will be fully illuminated and the operating noise will be reduced.
6. Disconnect the plug.

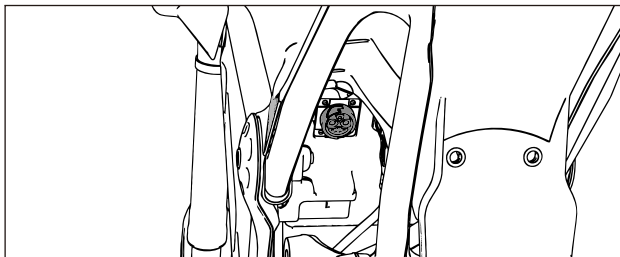

Be careful

Charge the battery regularly

To avoid completely draining the battery charge

Do not turn on the battery while it is charging in the vehicle.

Warning!

- Please note that never drain the battery until it is completely depleted, otherwise, it will permanently damage the battery. A damaged battery caused by over discharge due to improper operation cannot be repaired and must be replaced at the expense of user.

6.14 Remove the battery

- Remove the cushion (1)
- Open the locking mechanism (2)
- Take off the battery cover (3)
- Unplug the communication plug (4)
- Unplug the power supply (5)
- Lift up the battery (6)

6.15 Insert the battery

- Insert the batteries in reverse order.

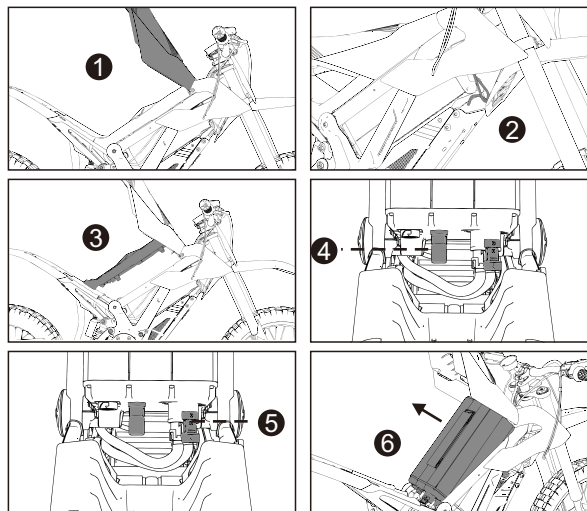

6.16 Front Shock Adjustment

- The knob above the front shock absorber is responsible for rebound damping adjustment

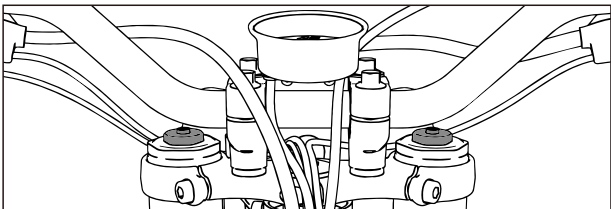

* The rebound damping knob controls the damping during rebound. If the knob is turned clockwise, the shock rebound is slower. If the knob is turned counterclockwise, the shock rebound will be faster.

- The knob below the front shock absorber is responsible for the compression damping adjustment.

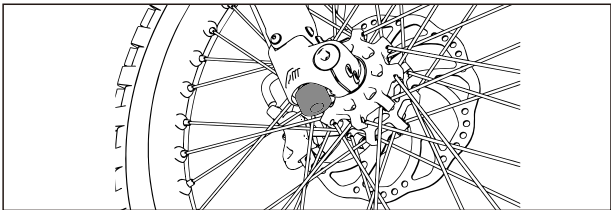

* The compression damping adjustment knob controls the damping during compression. If the knob is turned clockwise, the compression of the damper becomes stiffer. If the knob is turned counterclockwise, the compression of the shock becomes softer.

6.17 Adjusting the rear shock

- Adjusting the rear shock preload
 - To adjust the spring preload of the damper, please turn the adjusting knob on the top of the damper (1)
- On the lower side of the damper is the rebound adjustment knob (2).
- The adjustment knob for compression damping (3) is located at the top of the shock

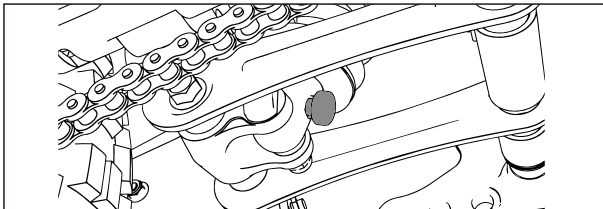
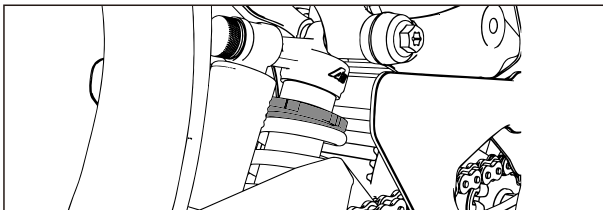

* The rebound damping knob controls the damping during rebound. If the knob is turned clockwise, the shock rebound is slower. If the knob is turned counterclockwise, the shock rebound will be faster.

* The compression damping adjustment knob controls the damping during compression. If the knob is turned clockwise, the compression of the damper becomes stiffer. If the knob is turned counterclockwise, the compression of the shock becomes softer.

7. Inspection before riding

Caution

For your safety, please check the condition of your vehicle before each use so as to avoid safety incidents caused by vehicle failure.

Warning!

- If a part of the vehicle is found to be defective, do not ride the vehicle.
- The manufacturer does not provide any warranty for problems caused by negligence of authorized dealers or lack of care and maintenance of the vehicle user. The manufacturer does not provide any warranty for damage to the vehicle or safety accidents due to violation operation.

7.1 Check list before riding

Items to be checked	Contents to be checked
Brake System	Carry out a check when the vehicle is at a standstill.
	When you squeeze the brake, you must not hold the brake lever all the way close to the handlebars.
	The braking system must work with a constant pressure. If it takes several repeated pull of the brake lever to achieve the required braking force, contact an authorized dealer to inspect the brake system.
	Check the brake lines for fluid leaks.
	Check the brake pads. If the brake pads are worn to only 1 mm at any point, replace two pads
Tire	Check whether the wheels are running properly.
	Check whether the tires are damaged and the treads of tires are too shallow
	Check tire pressure and correct if necessary
Throttle	Check whether the function of the throttle is normal, and the rotation is smooth without jamming. Whether the return position is normal.
Side Stand	Check the operating status. If the vehicle power is on and the throttle lever is turned, the side stand must be folded.
Body and Hanging Device	Check whether the bolts, nuts and screws are tight
Chassis	Check the function of the shock absorbers by compressing them several times. Also check the front and rear shock absorbers for leaks and dirt.
	Apply the front brakes and push down on the handle several times to check whether the front shocks are working properly. Press the seat hard several times to check whether the rear shock absorber is working properly.
Display and Lighting	Check whether all lights on the display and vehicle are working properly. It is especially important in order to be noticeable to other traffic participants.
Battery	Make sure the battery is always fully charged before use.
Steering	Check whether there are no faults and lubricate the steering pivot if necessary

8. Riding operation

Warning!

- Before departure, please familiarize yourself with all of the control components of the vehicle and how to operate them. Contact your dealer if you have any questions.

8.1 Starting

Turn the key to 'ON'

Caution

Make sure the battery is properly installed and fully charged.

8.2 Riding

1. Retract the side stand
2. Sit on the seat.
3. Hold the brake for more than 2s, the instrument shows ready status
4. Slowly turn the throttle (right) to start riding.

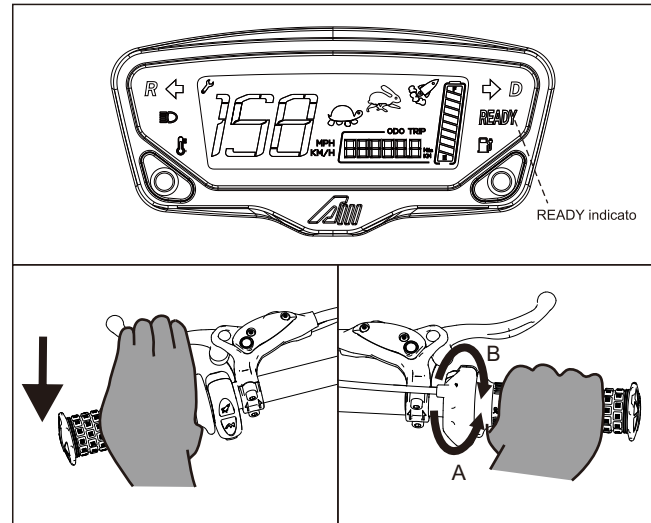

8. Riding operation

8.3 Throttle

- To accelerate, turn the throttle to the direction (a); To decelerate, turn the throttle to the direction (b), and use the brake.

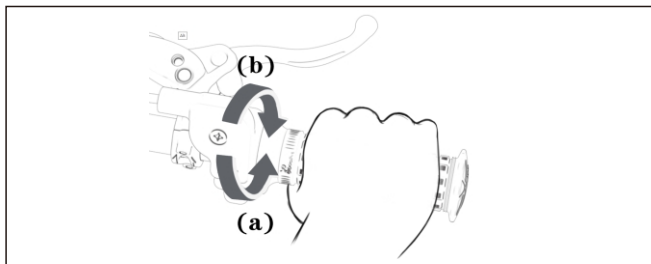

8.4 Braking

- Turn the throttle fully (b) with no tendency to continue accelerating.
- Use the front and rear brakes simultaneously and increase the braking force evenly

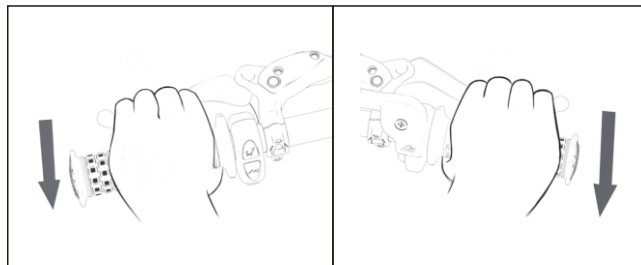
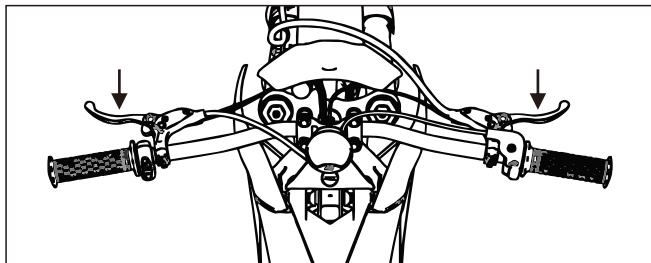

Rear Wheel Brakes

Front Wheel Brakes

Warning!

- Avoid sudden or violent braking, which can cause the vehicle's tires to skid.
- Braking distances will be extended when braking is applied on slippery surfaces.
- Avoid traveling in bad weather such as heavy rain.
- Drive on dry roads. Slowly descend slopes
- Control the vehicle and avoid overheating the brakes

8.5 Selecting a riding mode

Use the ride mode button (1) and select three modes :

- Tortoise mode: in this mode, the power output is limited, and the tortoise icon on the instrument is dynamically flashing
- Rabbit mode: in this mode, more power is available. The rabbit icon on the instrument is dynamically flashing
- Rocket mode: press the rocket button to enable this mode, then, it continues to output the maximum power, and the rocket icon on the instrument is dynamically flashing

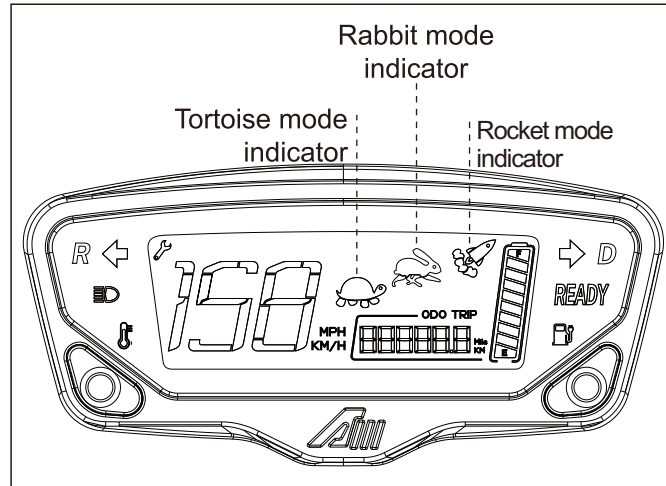

8.6 Parking

- Turn off the main switch of the vehicle
- Put down the side stand.

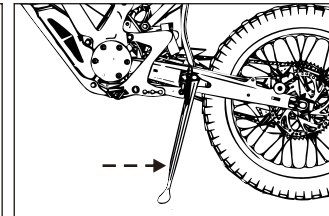
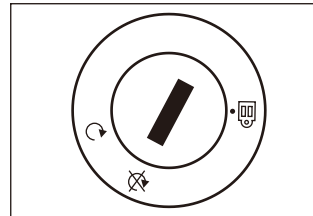

Warning!

- Make sure that the vehicle is parked on a stable and level ground

9. Regular maintenance and minor repairs

- The safety and condition of your vehicle are influenced by the proper maintenance, regular inspections, adjustments and lubrication. In the following pages, you will refer to the corresponding instructions. Maintenance information can help you with preventive maintenance and minor repairs. However, some maintenance operations require special tools.

Warning!

- Do not perform any maintenance work that you are not familiar with or that could affect the warranty service

- Changes to your vehicle that are not authorized by the manufacturer may result in changes to the vehicle's performance and affect safe driving. If the customer makes such changes without the manufacturer's authorization, the warranty claim would be invalid.

- Make sure the tires are at room temperature when checking tire pressure. Please check the tire pressure before each trip to ensure that the tire pressure is at a normal level

Caution

Maintenance work must be done by authorized professional distributors

9.1 Tires

- For optimal performance, durability and safe operation of your tires, please refer to the following tire instructions.

Tire pressure

Tire pressure must be checked before each trip and corrected if necessary. Check tire pressure on a regular basis.

Tire Pressure	
Front Tire	1. 8Bar
Rear Tire	1. 8Bar

Warning!

- Do not overload your vehicle. The higher the load on the vehicle, the higher the pressure when the tires rotate and the higher the resistance of the tires, brakes and steering. This can lead to damage or accidents. A reasonable weight distribution on your vehicle is important for your safety!

9. Regular maintenance and minor repairs

• Tire Inspection

1. Tread depth inspection
2. Tire sidewall inspection
3. Tire wear warning line inspection

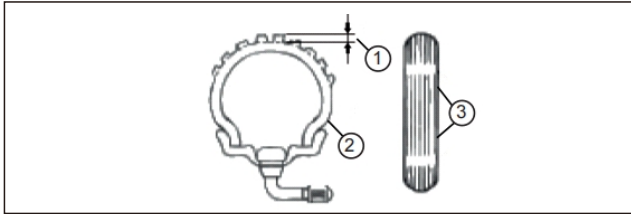

Warning!

- Please check the wear of your tires before each trip. If you find that your tires have reached the tire wear warning line, please contact a professional to replace with new tires immediately.
- This is necessary for your safety

Caution

The values we give are technical and may differ from the legal requirements in your area.

Minimum tire tread depth

Front and rear: >3 mm

Warning!

- Tire wear may affect the stability of the vehicle.
- Do not continue riding if the tires are worn to the limit or if they are damaged. It is the responsibility of the dealer to check the condition of the tires when selling the vehicle and when performing maintenance work on the vehicle.

Size of tires/rims

Front

Rim: 1.6x19

Tire: 70/100-19

Rear

Rim: 1.85x18

Tire: 90/100-18

*In order to ensure the best performance, durability and safe operation of the vehicle, please operate the rim in question according to the following instructions

*Check the rims for cracks and deformation before every ride. Have damaged rims replaced by an authorized dealer. Do not make any repairs to the rims yourself. A deformed or broken rim must be replaced.

9. Regular maintenance and minor repairs

9.2 Braking System

1. Brake Tie Rods

Caution

Please check the front and rear brake lever to ensure that they are working effectively.

Make sure that the brake system provides sufficient braking power. If abnormalities are found, please contact an authorized dealer to check the brake system

Warning!

- If you pull the brake lever and find that the braking effect is reduced by a soft feel. This is due to water or air entering the braking system, which will result in braking power reducing and can lead to loss of control.
 - If this is found, please contact an authorized dealer immediately!

2. Brake Pads

- The front and rear brake pads must be checked before each journey and according to the maintenance table

• Brake Pad Inspection

If the brake pads are worn to a thickness of 1mm, contact an authorized dealer for a new pair of brake pads.

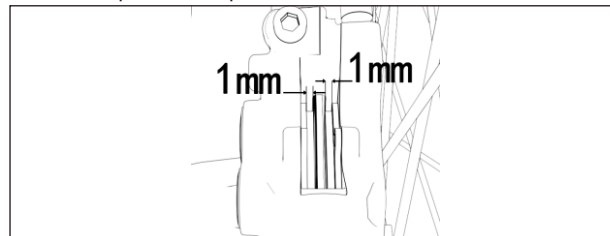

3. Brake Fluid DOT4

If you encountered problems with your brakes, please contact an authorized dealer. Brake fluid can only be checked and replaced by that dealer.

Please ensure that the brake fluid is always filled with (1) the brake fluid viewing window and that the brake fluid is clear. If there is any abnormality (reduced brake fluid, turbidity), please contact the authorized dealer in time and change;

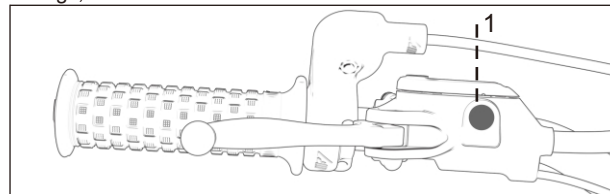

9. Regular maintenance and minor repairs

9.3 Lubricating the brake levers

- The turning points of the brake levers of the front and rear brakes must be lubricated on a regular basis.
- Turning points of the brake lever

9.4 Side stand

Caution

Check the side stand on a regular basis
Lubricate the metal friction surfaces of the side brackets on a regular basis

Warning!

- If the side stand do not fold smoothly, please contact an authorized dealer.

9.5 Suspension components

• The suspension components (front shock absorber and rear shock absorber) must be checked briefly before each trip and repaired the same if necessary. The shock absorber must be smooth and shake-free. Otherwise, please ask an authorized dealer to check the vehicle.

• Check the shock absorbers

1. Park the vehicle horizontally and upright
2. Check the running surface (1) for scratches, damage and oil leaks.
3. Using the front brake, push the handle down several times to check if the front shock absorber is working properly.
4. Press the seat hard several times to check whether the shock absorber is working properly or not.

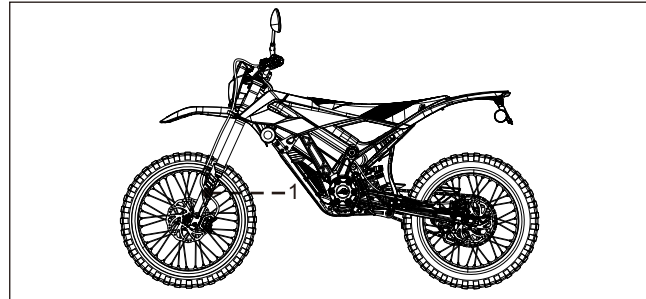

Warning!

- Before riding, please check that the front shock and shock guard will not interfere with the tires and brake system, which may lead to a safety accident.
- If this is found, please contact an authorized dealer immediately.

9. Regular maintenance and minor repairs

9.6 Steering Bearing Inspection

1. Place the vehicle on the lift and remove the front wheels
2. Lift the front shock and try to wiggle it back and forth.
3. If a wobble frame condition is detected, contact your dealer to have the steering system checked.

Warning!

- Please check the steering bearing regularly. A worn or loose steering head bearing is dangerous.
- Please maintain and lubricate the steering bearings regularly, and replace them if necessary.

9.7 Wheel bearings

The wheel bearings of the wheels must be checked according to the service chart

Caution

If you find a play function on the wheel, or if the wheel does not turn easily, please check whether the wheel bearing is authorized dealer.

9.8 Chain Tension

• Incorrect chain tension can damage the chain discs, bearings, sprockets or the chain itself. In the worst case, the chain may break or jump over the sprockets, which might lead to traffic accidents. Adjustment to the chain tension shall follow:

1. Loosen the axle nut (1)
2. Loosen the lock nut (2)
3. Turn the adjusting screw (3) to set the correct tension.
4. When there is no load on the vehicle, the chain tension should be

5-10mm (4)

5. Tighten in reverse order.

- Tightening torque
Rear axle nut(1) 8 5 - 9 5 Nm

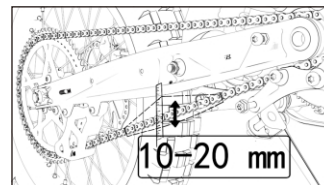
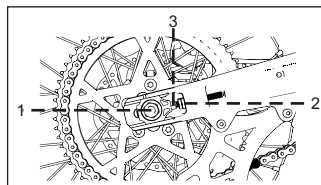

9.9 Battery

- The vehicle is equipped with a maintenance-free battery
- Never open the battery, which would be dangerous and would permanently and severely damage the battery. Please ensure that the battery is kept out of other hazardous environments such as open flames or cigarettes, and that there is adequate ventilation.
- When charging the battery indoors, make sure that the battery is always placed in a safe place.
- Charging the battery

For information on charging the battery, see the chapter "Instruments and Operation".

9.10 Fuses

- If the vehicle's instrument panel does not work after the circuit breaker and main switch are turned on, it may be caused by a blown fuse.
- Replace the fuse
 1. Turn off the circuit breaker and disconnect the battery.
 2. Open the white and transparent fuse holder front of the battery, and replace the fuse.
- Glass tube fuse 10A
 3. Check the function of the electrical components.
 4. If the fuse breaks again, contact your dealer to check the electrical system.

10. Trouble shooting

- Although your vehicle has been thoroughly checked before delivery, problems may also occur during operation.
- If your vehicle needs to be repaired, please contact an authorized dealer who has the necessary tools, expertise and experience to properly repair your vehicle. Please use genuine factory parts for repairs. Replicas may look similar, but are often of lower quality and can cause more serious damage.

NO.	Symptom	Error code on the display	Reason	Troubleshooting method
1	When the bike is powered on , the "ready"light doesn't activate		1.kickstand switch fault 2.brake switch fault 3.The emergency switch is damaged or the key is not in place	1.Pls remove the kickstand switch or change it 2.Pls remove the brake switch or change it 3.Pls put the emergency switch back or change it
2	The bike is powered on and activate the "ready"light, but the motor doesn't work	1. 10 1. 20 2. 30 2. 50	1.battery fault 2.controller fault 3.motor fault 4.Throttle fault or cannot return back 5.Brake power off switch is damaged	1.Pls check the cable or change the battery 2.Pls reconnect and tighten the place have been repaired 3.Pls reconnect and tighten the place have been repaired 4.Pls check the connector and cable of throttle or change throttle 5.Pls check the brake lever and brake switch
3	Failure of speed regulation or the max speed is lower	1.The display only shows two grids of battery power 2. 11 21 3. 21 4. 31 5. 50	1.When the battery capacity is lower than 20% ,will enter into the turtle mode 2.The battery temperature is higher than 60 or lower than 0 3.The controller temperature is higher than 90 4.The motor temperature is higher than 120 5.The throttle fault	1.Pls charge the battery fully 2.Pls wait for the resume of temperature 3.Pls wait for the temperature is lower than the limit value 4.Pls wait for the temperature is lower than the limit value 5.The maintenance center change the throttle controller
4	Insufficient mileage of a single charge		1.The tire pressure is insufficient 2.Not Charge the battery fully or charger fault 3.The brake adjustment is not ok , the driving resistance is excessive. 4.The battery is aged or damaged 5.There are too many uphill, headwind, frequent acceleration and deceleration, heavy load	1.Pls make sure the tire pressure is appropriate 2.Pls charge the battery fully or check if the charger plug connect well or not 3.Pls adjust the brake assay again 4.Pls change the battery 5.It is normal to reduce the mileage in this certain environment
5	The charger doesn't work	1.Two lights are flashing 2.Three lights are flashing 3.Four lights are flashing 4.Five lights are flashing	1.Battery undervoltage (lower than 44V) or output short circuit 2.Battery overvoltage (higher than 85V) 3.The positive and negative terminals of the battery are connected back or the battery is overheating 4.Charger fault 5.The charger plug falls off or the connection is loose	1.Restore the voltage above 56V or replace the battery 2.Reduce the voltage to less than 84V or replace the battery 3.Check the connection plug and wait for the battery temperature to drop below the limit value. 4.Wait until the temperature of the charger is lower than the limit value or replace the charger 5.Check whether the charging input and output plugs are connected properly
6	Noise of plastic body in driving		The tightness of the chain is not reasonable	Adjust the tightness of the chain
7	Other Fault		1.When you meet a fault that cannot be removed under the above guidance or a fault that cannot be determined. 2.The damage of motor, controller, charger and battery	If have these situation, please contact the supplier or the maintenance station. Do not open the above parts without authorization, otherwise you will lose the warranty commitment of the company.

11.1 Cleaning the vehicle

- Regular and proper cleaning of your vehicle will extend its life of service
- Preparation
 1. Wait until the motor cools down.
 2. Close all covers and electrical connections to prevent from water.
- Do not use gasoline, rust remover, brake disc cleaner, etc. to clean plastic parts and painted parts, as this will cause them to deteriorate and be damaged. Clean the vehicle as soon as possible after it has been driven in an environment containing salt.

Caution

It is best to clean the vehicle only with water and mild detergents or special cleaners provided by the professional dealers. Acidic cleaners are prohibited from cleaning the vehicle. If such acidic cleaner are used accidentally, please clean the area immediately to avoid damage to the vehicle. Then, use a dry towel or sponge to dry the vehicle.

Please always follow the care and cleaning instructions provided by the manufacturer

Safety

Do not use high-pressure water guns or steam cleaners to clean the vehicle. This may cause water to enter bearings or electrical components, such as connections, switches or lighting, and may cause damage to brake pads, seals, paint or other parts.

Caution

Salt is of extreme corrosion

Therefore, these cleaning instructions shall be abided by: wait for the motor to be cooled, as well as use water and a mild detergent. Clean all metals and then treat parts with rust inhibiting spray, including inscriptions and nickel plated parts

Clean the dirt with warm water, a mild detergent and a soft, clean sponge. Then rinse thoroughly with clean water. Use a small brush to clean hard-to-reach areas.

11.2 After cleaning

In order to avoid rusting, we recommend the use of a suitable care product

Warning!

- Make sure that no cleaning agents and lubricants are left on the brake discs, which may cause the brake system to fail while the vehicle is in motion and cause safety accidents. If the brake system is contaminated with such substances, please remove them before use

11. Cleaning and storage

11.3 Store the vehicle for a long time (two weeks and more)

- Clean the vehicle.

1. Remove the battery from the vehicle. Follow the instructions in the chapter “Instruments and controls”.

2. Check or adjust the tire pressure and lift the vehicle off the ground so that all wheels are not in contact with the ground. If this is not possible, rotate the tires every month to avoid damage caused by partial stress on the tires over time.

Warning!

- If you are not familiar with the battery, please contact a specialist dealer.

Caution

Always keep the battery charged. Storing a depleted battery will cause permanent damage to the battery

11.4 Battery Storage

• If the vehicle has not been used for more than one month, remove the battery from the vehicle, charge it, and store it in a dry place at 0-40° C. If the battery is stored for more than two months, check the battery level at least once a month and recharge the battery, if necessary.

- If store the battery for a long time, keep the battery cool and dry, and charge the battery for 2 hours every 3 months;
- Charge the battery before reinstallation.
- After installation, make sure the battery cables are properly connected.

Warning!

- Store the vehicle in a well-ventilated area. High humidity air can cause rust and corrosion. If you are not familiar with the battery, please contact a specialist dealer.

11.5 Short-term storage of the vehicle (within two weeks)

Store the vehicle in a cool, dry place, protected by a tarpaulin if necessary

12. Technical Specifications

Battery
Capacity 74V / 2590Wh, LG Premium 21700 lithium cells, removable, can be charged in bike or separately.
Brakes Front and Rear 4-piston hydraulic disc, 210mm
Charging 2.3h with Quickcharge Function
Controller Sine wave, Best-in-class power density and state-of-the-art motor control algorithms.
Drivetrain
Electric motor Air cooled Permanent Magnet Synchronous Motor, energy regeneration function, Direct drive, 420 chain with DX
Sprocket 11-58T
Rated power 4 kW
Peak power 4 kW**
Max torque of motor 46 N.m
Max Torque of rear wheel 242 N.m
Dimensions
Fork angle 24°
Ground clearance 340mm - 13.39"
Offset 15mm in triple clamps, 45mm in forks.
Seat height 860mm - 33.86"
Trail 111mm - 4.37"
Wheel base 1330mm - 52.36"
Fenders & Bodywork
Material PP/ABS plastic

Frame 6082 aluminum extruded, forged, CNC machined and steel frame.
Front suspension Upside Down, 200mm travel, Fully adjustable
Handlebar 6061 aluminium, 760mm length
Rear suspension Mono-Shock, 74mm travel, adjustable
Certificate CE EEC / EU,CCC / CN
Ride modes
Mode 1 Tortoise mode: The ultimate mode energy conservation exploration. Limited to 25 km/h with 3.5hrs battery range.
Mode 2 Rabbit mode: Enduro or active trail riding, 1-2 h riding time.
Mode 3 Rocket mode: Track and race mode, maximal torque and speed, riding time up to 1h.
Mode 4 Reverse mode: Limited to 9 km/h.
Speed & Range
Range 180 Km (Test data Load: 75 Kg, 20 Km/h uniform speed, ambient temperature: 25 °C, flat pavement, standard tires, standard tire pressure)
Top speed 45km/h
Weight
N.W of Battery 15 kg
N.W of whole bike 72 kg
Max load 120 kg
Wheels & Tires
Hubs Forged and CNC aluminium RFN hubs with 20mm axle.
Rims F 19"/ R 18" (Motorcycle standard) re-inforced, triple chamber, 7050 aluminium.
Tires KENDA 2.75-19" / 3.0-18" lightweight off-road tires for durability and minimum trail wear

13. Guarantee and warranty

Before using the vehicle, read the operating instructions carefully to familiarize yourself with the operation of the vehicle. The operating, care and maintenance instructions provided in the operating manual must be followed to maintain warranty and claim conditions. Compliance with the operating, care and maintenance instructions will be conducive to significantly increasing the service life of the vehicle.

The vehicle is guaranteed to be free from defects in material and manufacture of critical components for a period of 24 months (limited warranty) or the legally applicable warranty period as from the date of first handover to the final customer (see after-sales service and warranty coverage form for details). Repairs may only be carried out in our authorized and specialized workshops. No warranty or guarantee may be claimed in case of damage caused by handling, operation or disregard of the operating, care and maintenance instructions. Warranties or guarantees may only be given if any damage is reported directly to the seller or to our authorized professional workshop. Claims made under warranty only entitle the customer to have the defect remedied. No compensation will be granted for direct and consequential damages. No warranty or guarantee claims may be made for neglected vehicles. Therefore, please observe the following instructions.

The vehicle body and trim parts must be cleaned of dirt on a regular basis. Do not use high-pressure cleaners, strong water sprays, sharp, aggressive or abrasive cleaners. This can permanently damage the surface and paint work and promote the formation of rust. Please always use gentle care products. Your professional dealer will be happy to advise you. Please treat aluminum parts with a refined finish (chrome plated, anodized or other refined finish) with the appropriate care product to prevent oxidation. Please always protect frames and metal parts from corrosion with proper corrosion protection.

Vehicles that are permanently parked outside must be covered with protective tarps to prevent weathering of painted parts and cracking of seats and other plastic parts.

No guarantees or warranties can be required if the vehicle is used in any competition

15. Maintenance guideline

Important information

Maintenance shall be subject to time or kilometers, whichever earlier.

Warning!

- Please carry out suitable maintenance work on the vehicle.
- The warranty can only be granted if the vehicle has been maintained according to this plan

Caution

The vehicle must be continuously checked for rust. The owner is personally responsible for rust prevention

The inspection frequency must be observed, otherwise the warranty will be invalid.		1st 185 Miles (300KM) or 3 Months	2nd 620 Miles (1000KM) or 6 Months	Every 1000 KM or 12 Months	Every 3000KM	Every 2 years
component	activity					
display switch	Check	Check	Check			
electric system	Check	Check	Check	Check		
battery	Check	Check	Check	Check		
front-wheel bearing	Check and replace	Check	Check		Check	
rim	Check and replace	Check	Check	Check		
brake system	Check and replace	Check	Check		replace	
braking line	Check				Check	
brake disc	Check, clean and replace	Check	Check		clean	
braking fluid	Check and replace	Check	Check		Check	replace
brake pads	Check and replace	Check	Check	replace	replace	
chain, rear sprocket	Check, clean and replace	Check and clean	Check and clean		replace	
front shock absorber	Check and clean	Check	Check		Check and clean	
rear shock absorber	Check and clean	Check	Check		Check and clean	
steering bearing	Check	Check	Check		Check	
side stand	Check, clean and lubricate	Check, clean and lubricate	Check, clean and lubricate	Check, clean and lubricate		
tight of all visible screws and nuts	Check	Check	Check		Check	



WWW.RFNBIKES.CZ



WWW.FUNBIKES.CZ